

TOX®-ElectricDrive

Electrical drive technology – smart and intelligent

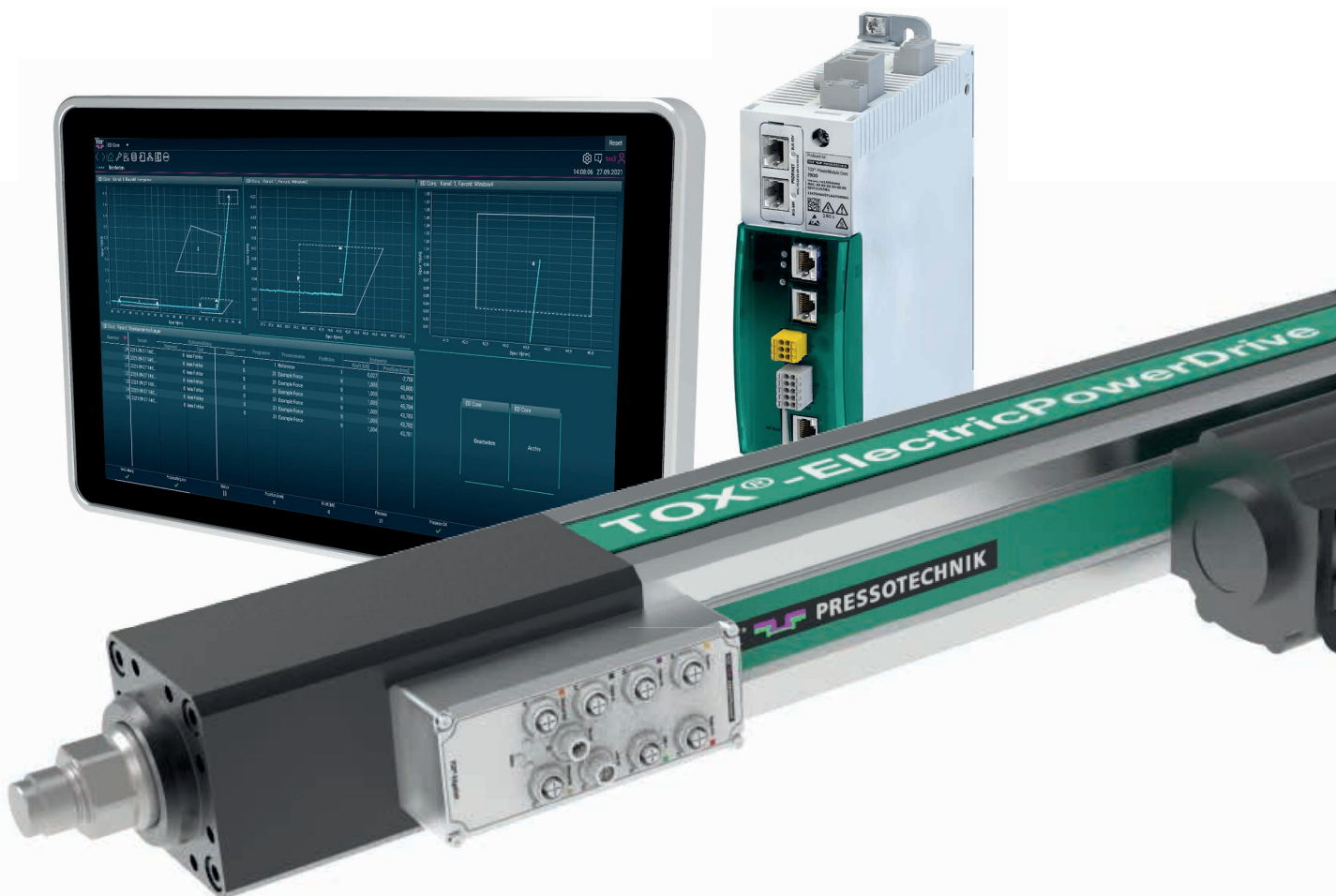

The TOX®-ElectricDrive Core System

The new TOX®-ElectricDrive Core-System with its electrical drives can be used in a wide range of applications. The highly flexible integration into existing control environments saves time and costs – drive control, process monitoring and quality assurance are combined in one system. The intuitive HMI meets all your requirements – you decide whether the TOX®-SoftWare is run on our HMI panel or on your PC on customer-side.

TOX®-ElectricPowerDrive

The powerful drives with forces from 0.02 - 1000 kN. Interfaces and sensorics offer highest flexibility.

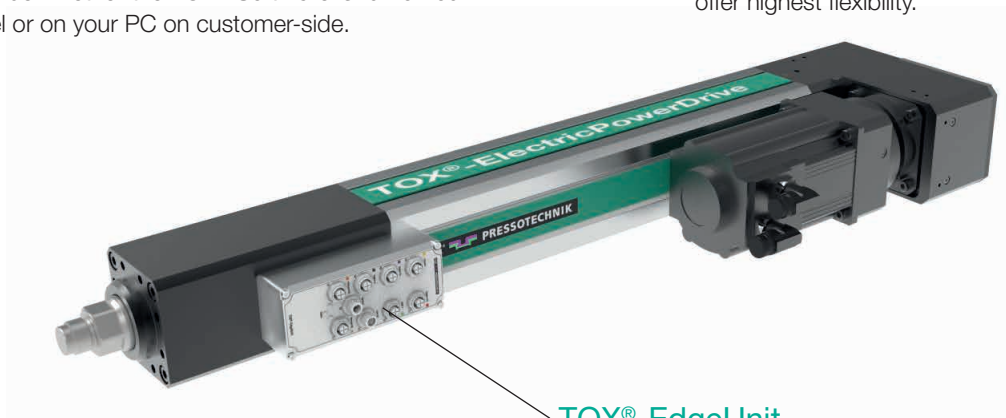

TOX®-EdgeUnit

TOX®-PowerModule Core

- Servo inverter with application for force-travel control included
- Main interface and connection to the fieldbus system
- All functions of your application are pre-parameterized



The decentralized intelligence for every drive



TOX®-SoftWare

- Visualization and HMI
- Storage of the quality data or forwarding to server
- Operating system independent (Windows/Linux)
- On customer PC / line PC or TOX®-UDI Panel (available in 10", 13" and 21")

System overview TOX®-ElectricDrive Core

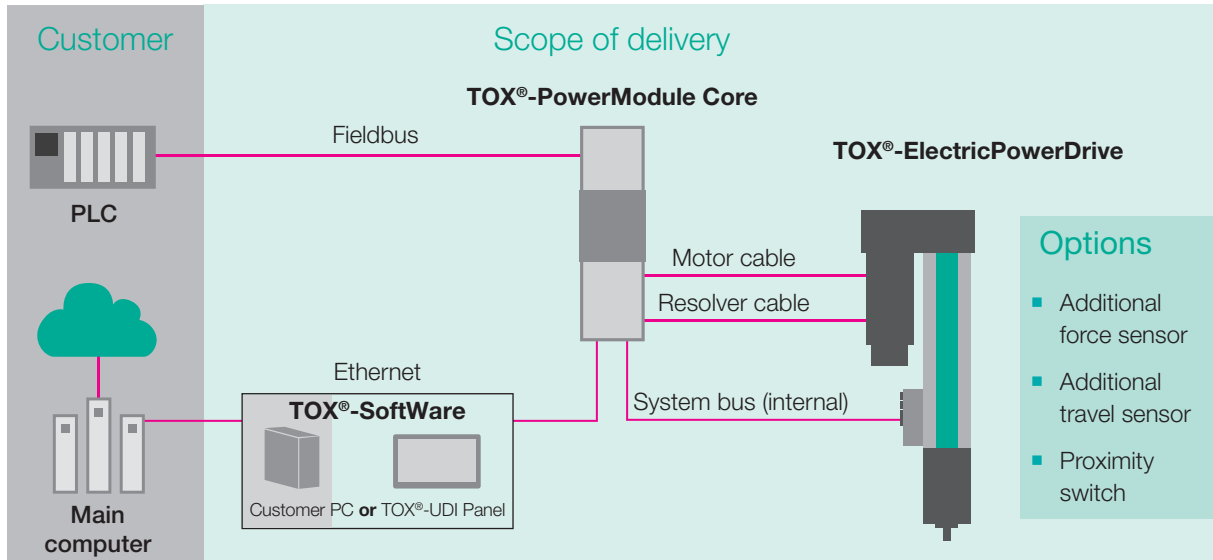

Advantages

- Fast commissioning due to the intuitive operation of the software: Plug-and-Play
- Cost saving due to slim control architecture
- Seamless quality assurance
- Predictive maintenance ready
- Quality data and evaluation in one system

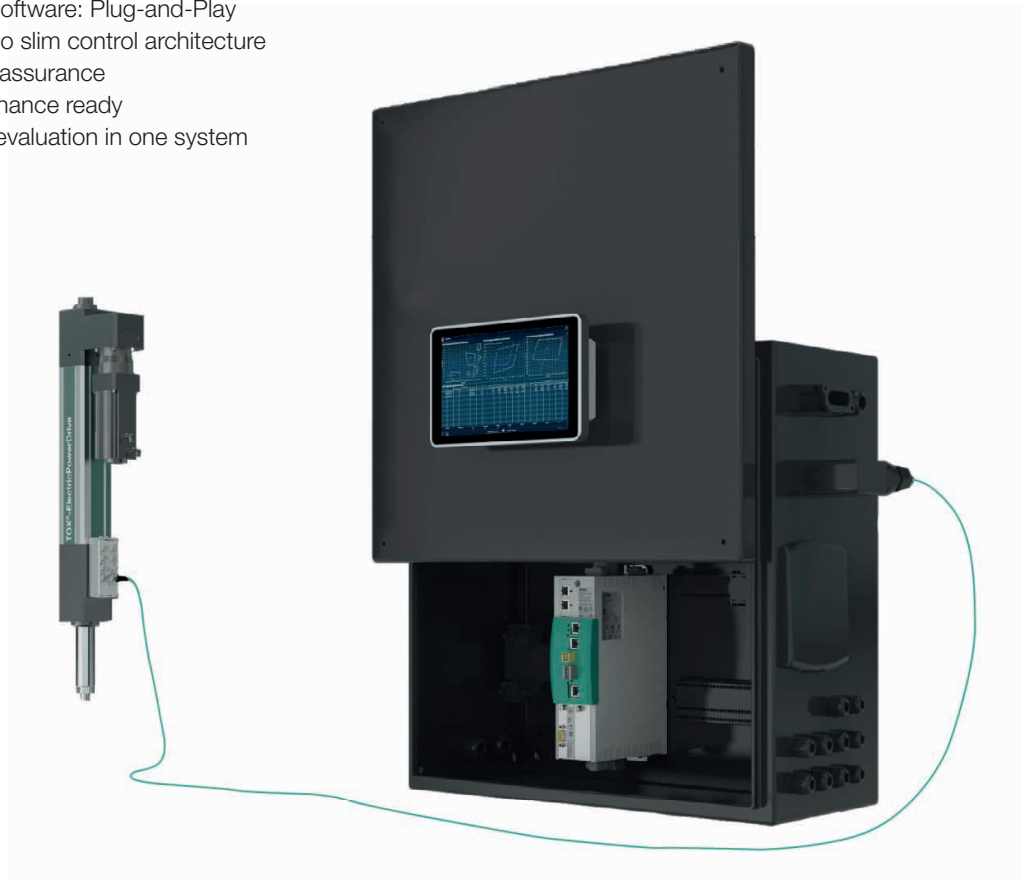

Versatile applications

The TOX®-ElectricDrive Core system is perfectly suited for precise and powerful use in joining machines, assembly machines, presses, robot tongs and special machines. The system ensures maximum productivity in a wide range of applications.

Joining and Assembling



Clinching

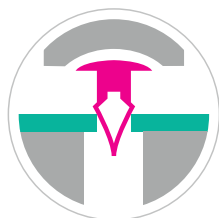

Clipping

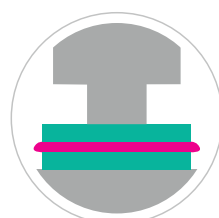

Pressing,
Compressing

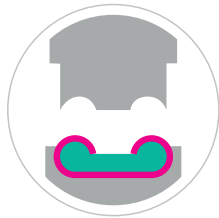

Crimping

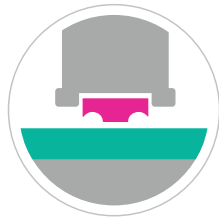

Insertion of
functional elements



Punching,
Piercing

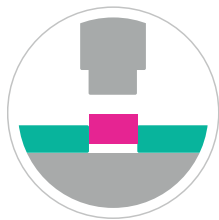

Press Fitting,
Installing



Riveting

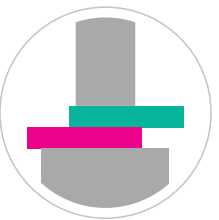

Tightening,
Clamping

Advantages of the drive system

- Common applications are pre-parameterized
- Easy adjustment of the process parameters
- Fast changing of applications
- All combined in one system





Forming



Bending



Molding

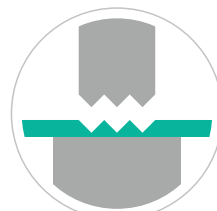

Stamping,
Marking



Deep drawing

Checking and Testing

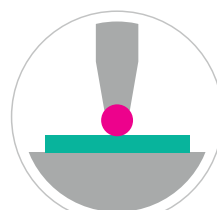

Checking,
Measuring

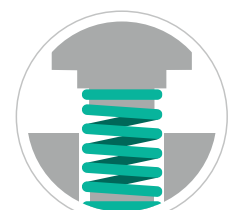

Testing

The electromechanical servo drive

TOX®-ElectricDrive provides an energy-efficient drive solution for various applications with a usable press force range up to 1000kN. The drives are equipped with either ball screws or planetary roller screws.

Low maintenance costs

The electromechanical servo drives TOX®-Electric-PowerDrive are designed in such a way that minimal maintenance is required.

- Maintenance-free servo motors
- Maintenance-free belt drive
- Long lubrication intervals of the drives (automatic lubrication systems are available)

Ball screw spindle

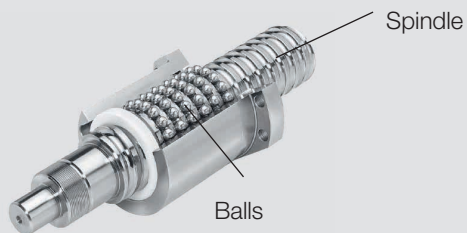

This screw assembly consists of a thread and a nut with recirculating balls in a closed system.

Planetary roller screw spindle

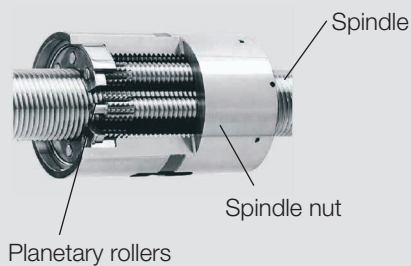

Here, planetary rollers installed in the spindle nut rotate around the spindle. The high number of force-transmitting contact surfaces can take high loads, with compact dimensions.

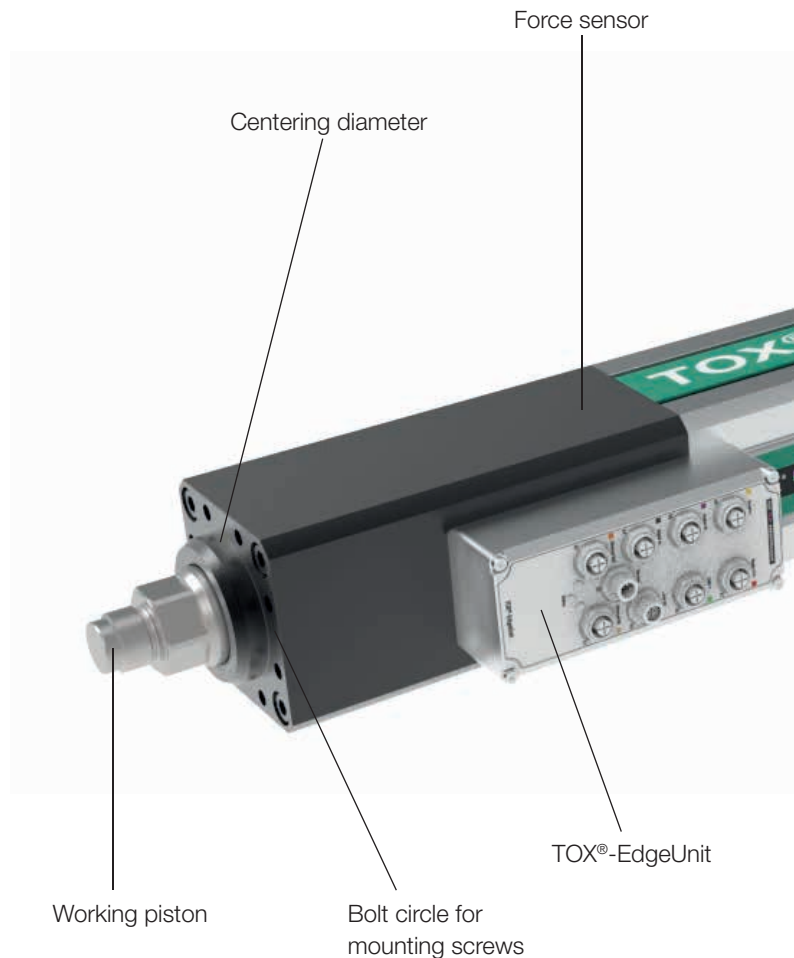

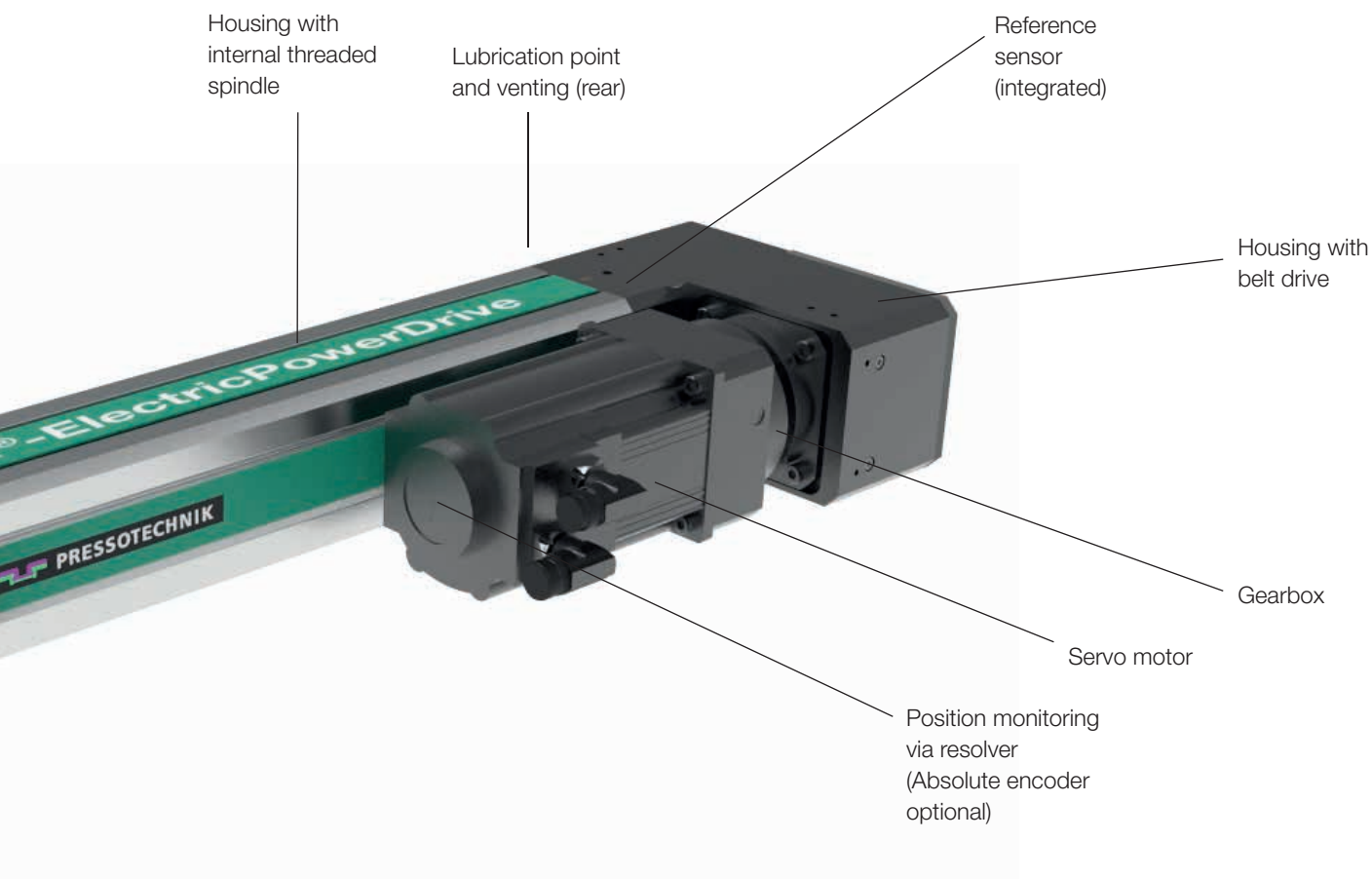

Proven Drive Technology

- Robust and durable
- High energy efficiency and low operating costs
- High mechanical precision
- Precise repeatability
- Anti rotation feature

Special versions

Design:

- Variable mounting version
- Variable lubrication position
- Frontal mounting of tools
- Modified stroke length
- Narrow design

Protection type:

- Protection type IP65

Cycle optimized:

- Long force holding time
- Reduced cooling time
- Force pulling or punching
- Increased speed



The complete electromechanical drive family

EQe

- Cost effective
- Ball screw spindle
- Polynom calibration
- 4-point force measurement

TOX®-ElectricPowerDrive EQe-K

- Press force range 0.02 kN – 100 kN
- Available in types
2 kN / 5 kN / 10 kN / 30 kN / 60 kN / 100 kN
- Total stroke 150/300/450 mm
- Speed up to 300 mm/s



Applications:

Pressing, joining, single drive with medium space requirement

EXe

- Smaller space requirement
- High precision, 4-element force measurement
- High power density with low weight
- Special versions for individual customer needs (length, speed, protection class)
- Planetary roller screw spindle
- Polynom calibration

TOX®-ElectricPowerDrive EXe-K

- Press force range 0.1 – 200 kN
- Available in types
10 kN / 30 kN / 60 kN / 100 kN / 200 kN
- Total stroke 150/300/450 mm
- Speed up to 300 mm/s



Applications:

Insertion of functional elements, clinching, riveting, space limited pressing applications, punching

TOX®-ElectricPowerDrive EXe-F

- Press force range 0.05 – 100 kN
- Available in types
5 kN / 10 kN / 30 kN / 60 kN / 100 kN
- Total stroke 150/300 mm
- Speed up to 800 mm/s
- Increased service life
- High acceleration

800 mm/s SPEED

Applications:

Press applications requiring short cycle times



TOX®-ElectricPowerDrive EXe-L

- Press force range 3 kN – 1000 kN
- Available in types
300 kN / 400 kN / 500 kN / 700 kN / 1000 kN
- Total stroke 300 mm
- Speed up to 90 mm/s

up to 1000 kN

Applications:

Multi-point clinching and riveting, high force press applications



Sensorics and Interfaces

The TOX®-EdgeUnit is the decentralized intelligence for every TOX®-ElectricPowerDrive. The integrated force sensor is directly located next to the measuring amplifier of the TOX®-EdgeUnit. No complex cabling – no susceptibility to electromagnetic interference. In addition, a second DMS measuring amplifier is available for closed-loop monitoring – a full-featured second measuring channel.

Integrated Force sensor

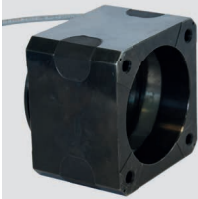

- 4 x DMS with < 0,5% measurement accuracy
- Spatial position independent itself compensating
- Internal connection with the TOX®-EdgeUnit
- Measurement amplifier and 16 Bit ADC

Intelligent TOX®-EdgeUnit

- Onboard memory for electronic type plate, service counter, stroke counter, drive data, calibration factor
- 2 digital inputs and outputs
- Encoder input
- 2 analog inputs
- Additional measuring amplifier (16-Bit)

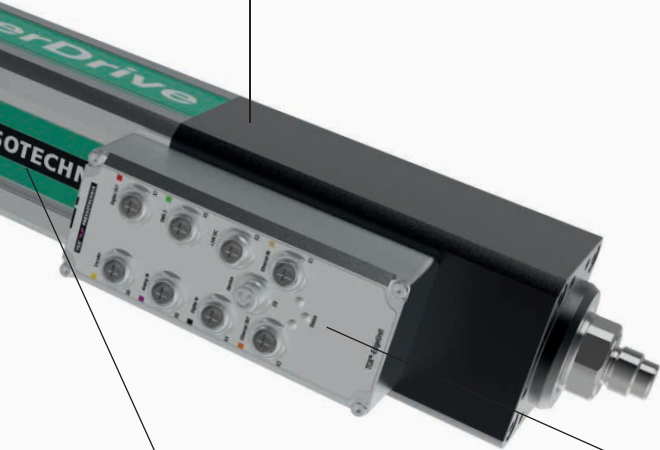

Integrated Reference sensor



- Internal connection with the TOX®-EdgeUnit
- Redundance for the reference (additional to currency increase or fixed stop)



TOX®-PowerModule Core

The TOX®-PowerModule Core serves as servo inverter for power provision in the system as well as central intelligence of the drive control. Furthermore, the fieldbus interface to the higher PLC/ to the higher robot is integrated.

The TOX®-PowerModule Core is parameterized with the TOX®-SoftWare. The connection of the TOX®-UDI Panel or customer PC takes place via Ethernet (TCP/IP).

Powerful Controller

- Force or function control
- Individual acceleration and deceleration
- Pressing in on PLC preset values
- Driving on position or on force or both combined
- Multiple operation (access to a process and task at once)
- Taring the force sensor

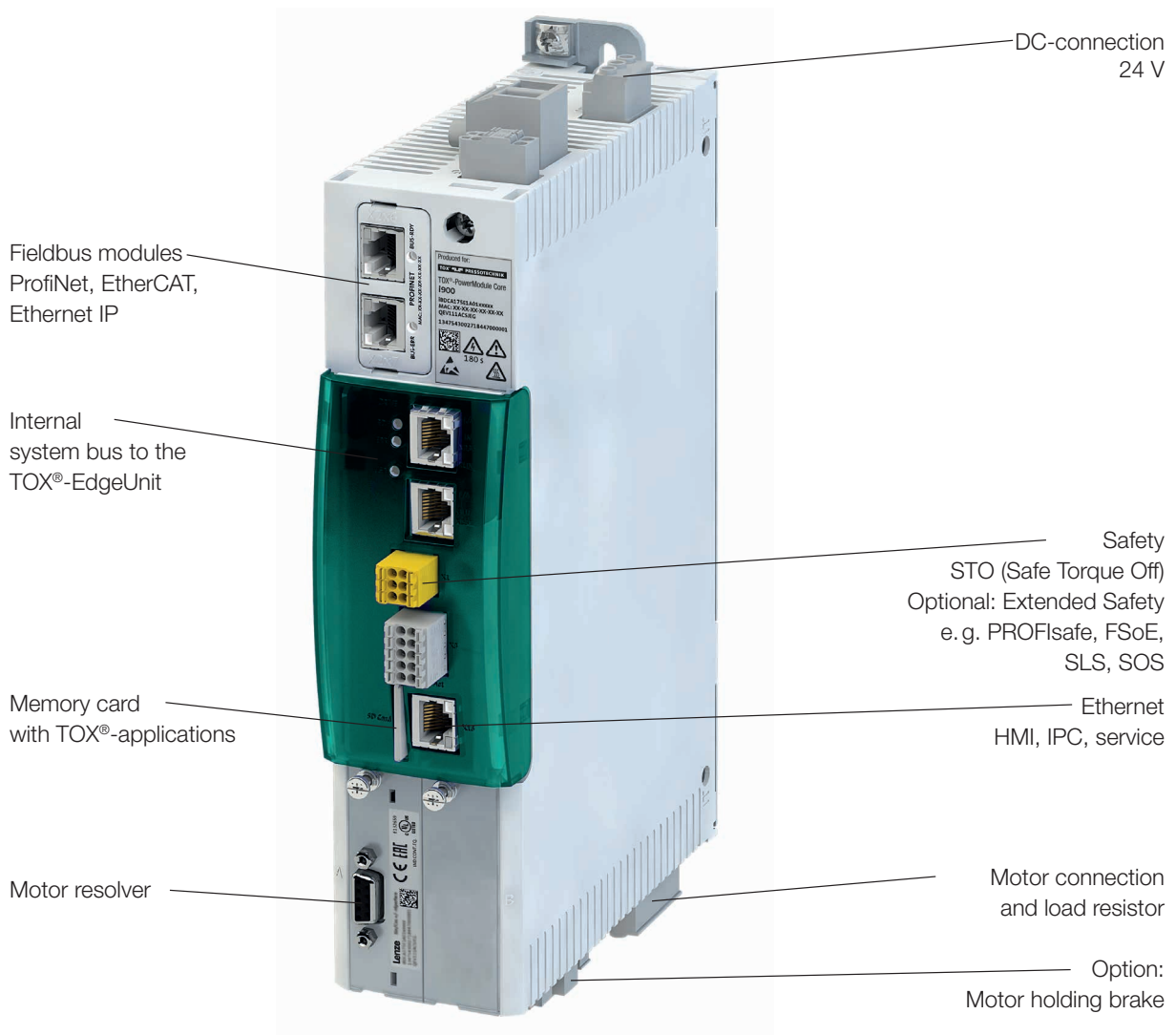

TOX[®]-SoftWare

Whether you are working with the new TOX[®]-SoftWare as operator, repairer, process engineer, commissioning engineer or quality manager, the HMI impresses with a customizable user interface as well as clear, freely definable dashboards. Parameterization, operation, process monitoring, diagnosis and evaluation as well as quality data management are all combined in the TOX[®]-SoftWare.

The TOX[®]-SoftWare takes over the control of the TOX[®]-PowerModule Core, which controls the TOX[®]-ElectricPowerDrive. The communication takes place in real time and guarantees high repeatability and highest performance of the process control.

Technical Data

- 5 windows per process freely definable
- 500 software programs
- 2 channels e.g. force 1 / force 2 on position
- Flexible fieldbus with 32 words
- 10 tracks in one diagram
- 5000 diagram points per track





Userfriendly Software

- Modern user interface „look and feel“
- Widget based for customizable dashboards
- Intuitive handling
- Easy installation and parametrization
- Integrated window technique for many applications

TOX®-UDI Panels

The TOX®-SoftWare can be installed either on a customer's PC or on a TOX®-UDI Panel. This is available in 3 different versions:

10"



Hand panel: upright or horizontal operation.

13"



For built in or mounting on a support arm, upright or horizontal.

21"



Technical Data

- Integrated PC
- IP 65 protection type
- No UPS battery necessary
- 250 GB SSD hard disk
- Resolution max. Full HD 1920 x 1090 Pixel

Process monitoring with Window Technique

During operation, the drive continuously supplies force-displacement curves, which are used for monitoring application processes. The TOX[®]-SoftWare takes over the evaluation of the curves and their documentation. On the basis of these measurement curves, the quality of an individual production step, an assembly or the entire product can be monitored and controlled in real time.

With the help of various windows, even complex XY curves can be monitored and controlled in detail according to requirements.

Must cross

OK **NOK**

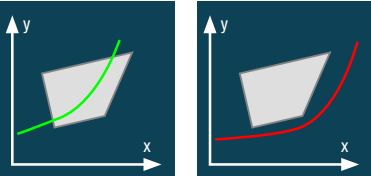

The curve must cross the defined window.

Application: Monitoring of the force-travel progress during pressing in of elements

Enter and Exit

OK **NOK**

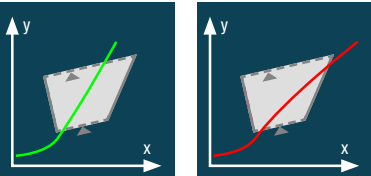

The entry and exit sides can be freely defined and will be monitored.

Application: Monitoring of the force-travel progress during pressing in of elements

Innovative Window Technique

- Complete process monitoring integrated (e.g. enter and exit points, touch and crosspoints)
- Window and Envelope Technique
- Calculation functions

Extended Lines

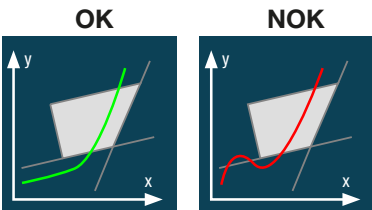

The extended lines define a region. The force-travel-curve must enter the window without touching and crossing these lines.

Application: Monitoring of the force-travel progress during pressing in of elements

Average

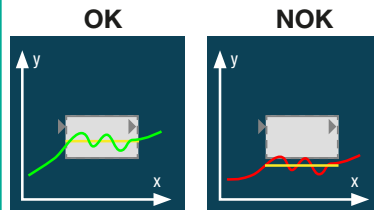

An average value is calculated and monitored within the window.

Application: Control of the average force applied to a piece part when clamping, forming or molding.

Time Monitoring

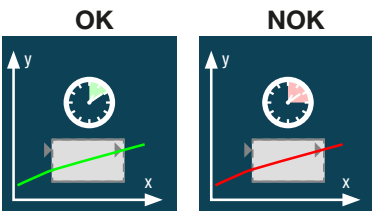

Detection of the time between entry and exit.

Application: Monitoring of time functions e.g. flowrate of material during deformation

Slope detection

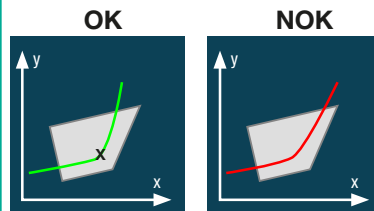

The slope has to reach a defined value. This value will be recorded and is relevant for other actions.

Application: Pressing in with force on piece parts with tolerances

Slope detection

Digital Input

Integral

Differential Average

Differential Actual Values

The actual gradient is recorded and evaluated (derivation).

Application: Evaluation of the fit tolerance of a piece part

Hysteresis

Intersection within the window

Load Drop

Forecasting

Two values are recorded and a calculation is performed which results in a new target window.

Application: Measuring of piece parts during pressing operations

Networked Production and Quality data

Digitization is making its way into industrial production. Modern information and communication technology enables self-organized production, so that people, machines, plants, logistics and products communicate and cooperate directly with each other. Intelligent and digitally networked systems are necessary for this.

Data Connection and Network

Thanks to numerous interfaces, the TOX®-ElectricDrive Core system can be excellently integrated into a network - be it a machine, a production line or an entire company network. The system components communicate with each other via fieldbus.

Quality data for further processing

The data generated there makes it possible to monitor and improve the processes on an ongoing basis. Feedback from the production process can be used to optimize technology parameters. Unnecessary maintenance work and downtimes can be avoided thanks to predictive maintenance.

Future-oriented Features

- Interfaces for connecting peripheral devices via Industrial Ethernet
- Plug & Play installation
- Fast application changeover
- Modular design
- Import of process parameters from the production network
- Dynamic adaptation of process settings
- Data exchange via communication protocols such as OPC UA and MQTT

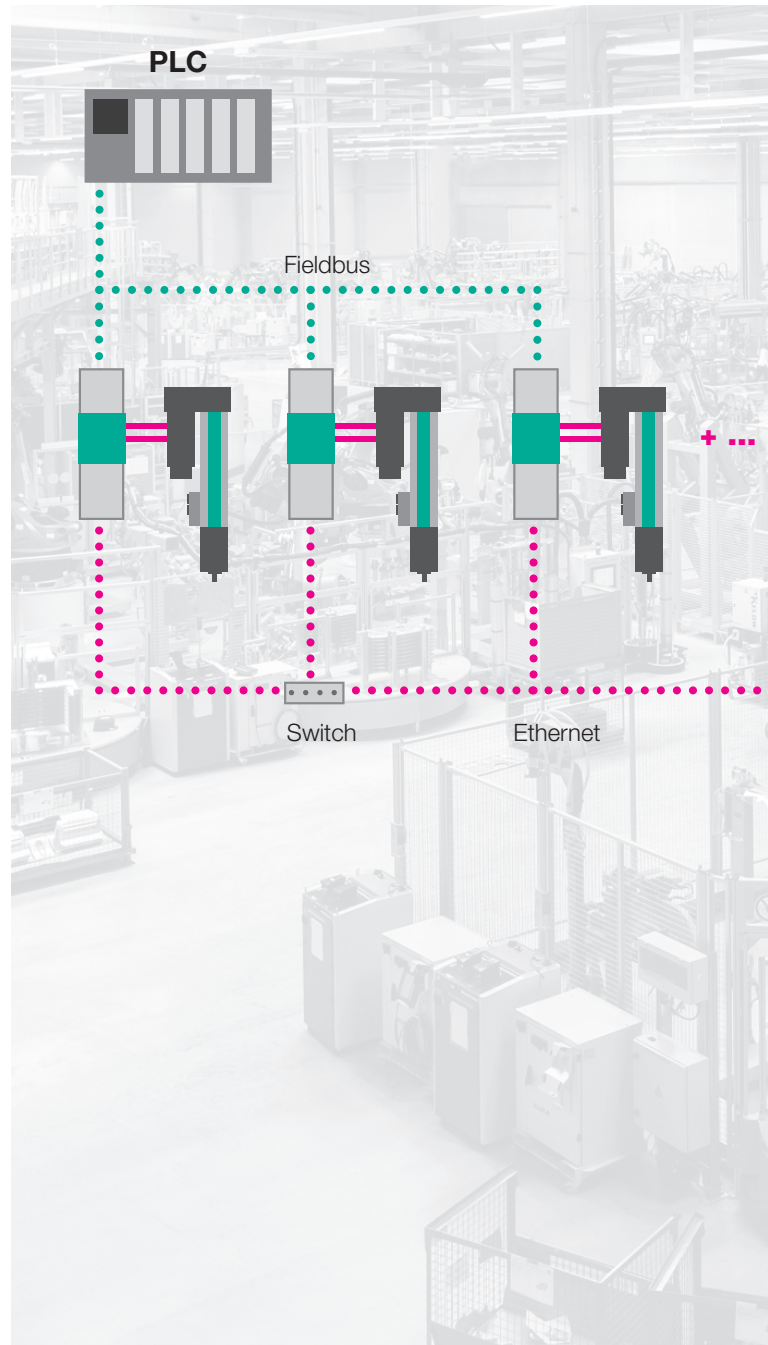

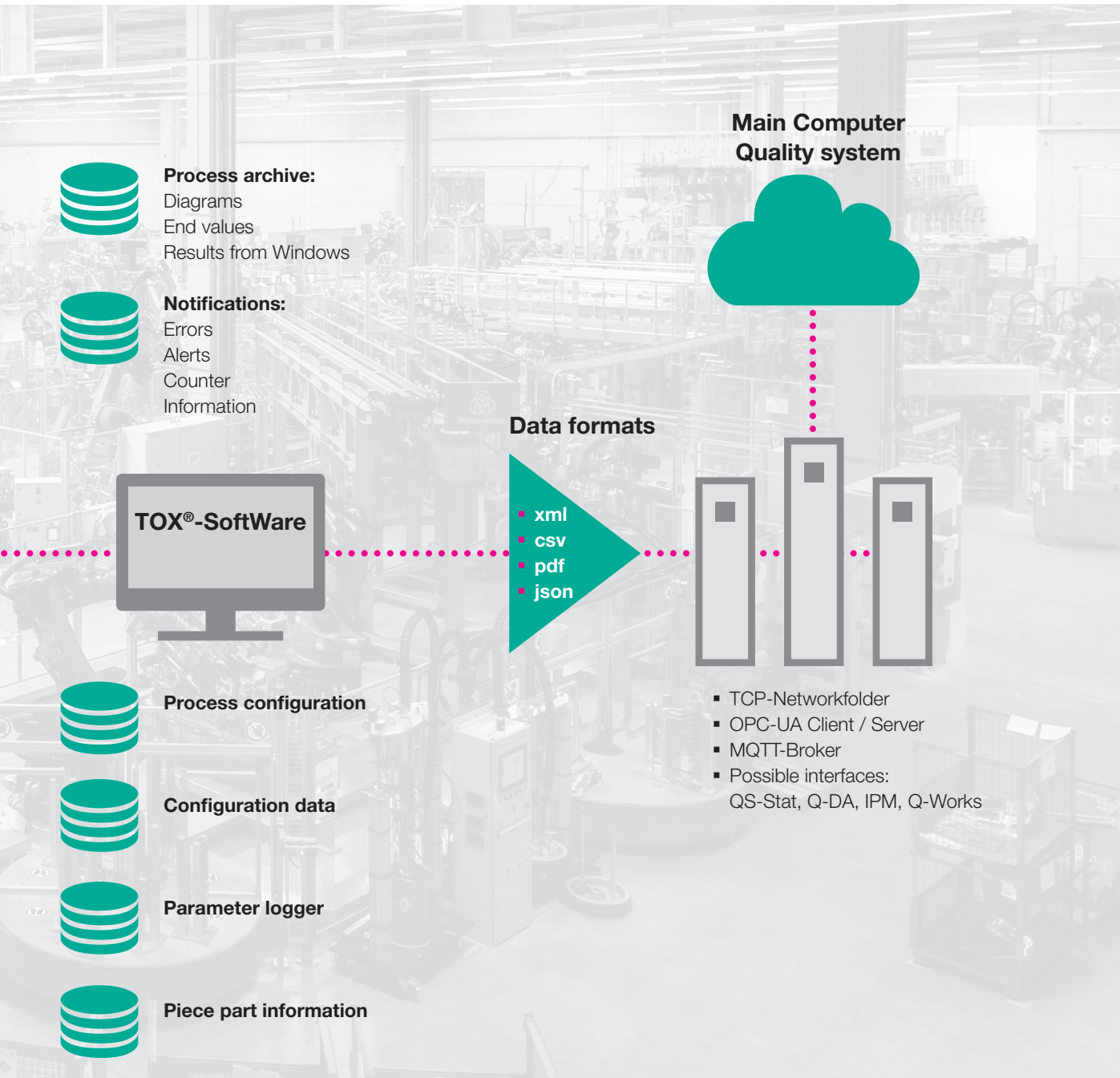

Accessoires and Options

With various accessories and expansion options, the system can be adapted and equipped to meet the individual requirements of the application.

Automatic lubrication device

All drives can be equipped with an automatic lubrication device. This ensures optimum, minimal lubrication of the drive.



Fan

The drives can be equipped with a fan. It cools down the motor to enable higher power draw and thus shorter cycle times.

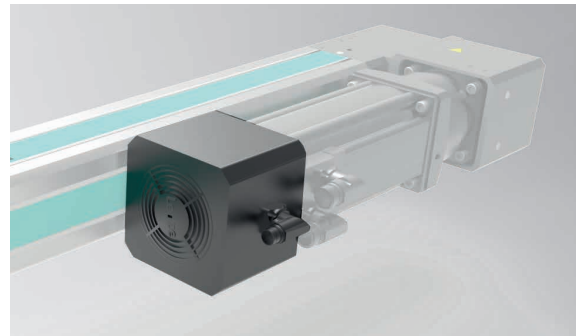

Force sensor

Additional force sensors at important positions measure the relevant forces.



Piezo-electric sensors

Upon request, a piezo sensor can be integrated.



Proximity switch

For detecting positions of workpieces and tools.



Travel sensor

The drive system can be equipped with sensors for precise deflection-independent measurement of travel, distance and position.



External linear position sensor

To measure distances between objects and a reference point or changes in length independent of deflection, external travel measuring systems (glass scales) are used.

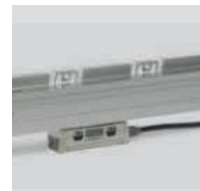

Safety Equipment

Motor holding brake (intern)

The motor holding brake prevents the weight-loaded working piston from dropping when the system is de-energized. The motor holding brake is connected via the motor cable included in the cable set.

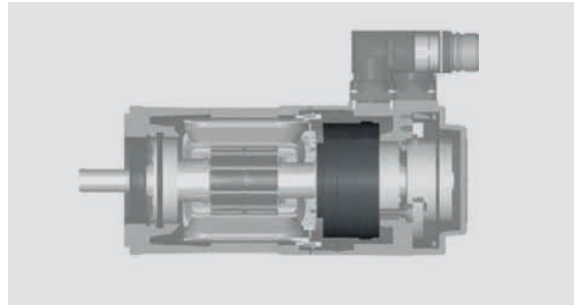

Safety brake (mounted on the drive)

The safety brake for the drives EQe-K, EXe-K and EXe-L is designed as a spring-applied brake. This means that when a power loss occurs, the brake closes and stops the drive and the dynamically loaded working piston.

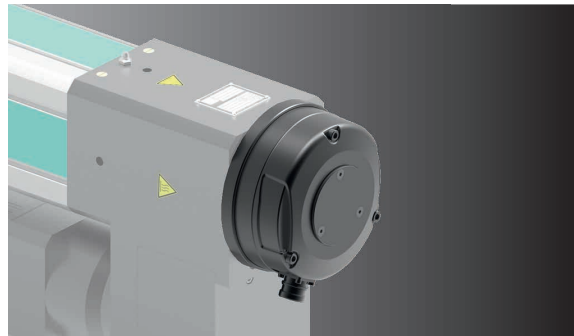

TOX-PowerModule Core with Extended Safety

Using the Extended Safety-Controller all safety options can be applied:

- SOS (Safe Operating Stop)
- SLS (Safely Limited Speed)
- PROFIsafe
- FSoE
- more on request



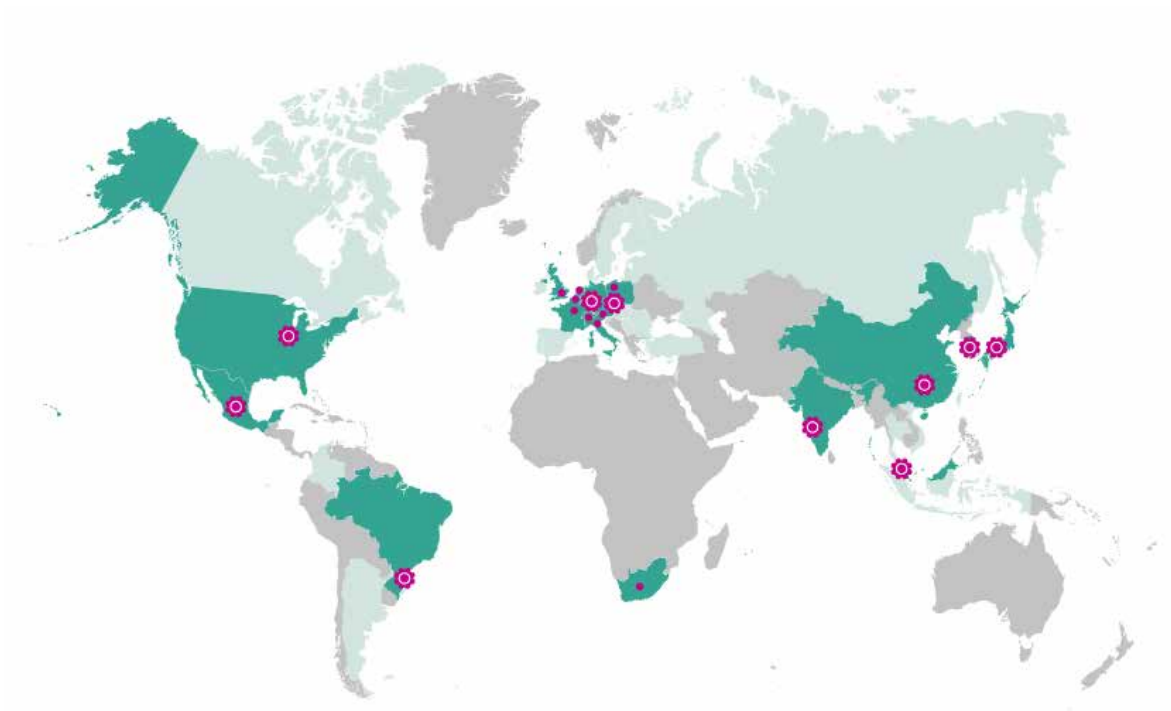

TOX®  PRESSOTECHNIK

TOX® PRESSOTECHNIK GmbH & Co. KG
Riedstrasse 4
88250 Weingarten / Germany

Find your local contact at:
tox-pressotechnik.com